

Non-Suited Accessories





Traditional Bell Push

		Standard	Distressed	ETERNA
25-8850-175	Small Traditional Bell Push	154.56	168.00	190.32
25-8850-262	Large Traditional Bell Push	162.40	173.60	185.92



Colonial Bell Push

		Standard	Distressed	ETERNA
25-8851-175	Small Traditional Bell Push	154.56	168.00	190.32
25-8851-262	Large Traditional Bell Push	162.40	173.60	185.92

All Prices in US Dollars - Prices Subject to Change Without Notice
Please Check with Customer Service for Up to Date Pricing.



Traditional Deadbolt

		Standard	Distressed	ETERNA
1885081	Traditional Deadbolt 2 3/8" Backset, Single Cylinder	218.40	246.40	268.80
1885041	Traditional Deadbolt 2 3/4" Backset, Single Cylinder	218.40	246.40	268.80
1885082	Traditional Deadbolt 2 3/8" Backset, Double Cylinder	246.40	268.80	291.20
1885042	Traditional Deadbolt 2 3/4" Backset, Double Cylinder	246.40	268.80	291.20



Colonial Deadbolt

		Standard	Distressed	ETERNA
1885181	Colonial Deadbolt 2 3/8" Backset, Single Cylinder	218.40	246.40	268.80
1885141	Colonial Deadbolt 2 3/4" Backset, Single Cylinder	218.40	246.40	268.80
1885182	Colonial Deadbolt 2 3/8" Backset, Double Cylinder	246.40	268.80	291.20
1885142	Colonial Deadbolt 2 3/4" Backset, Double Cylinder	246.40	268.80	291.20

Traditional and Colonial Bell Push

Traditional



- Solid Forged Brass. Available in Large and Small rose
- Colonial and Traditional Design Trim
- Fully Concealed Mounting
- Super Bright White LED Illuminated Push Button

Colonial

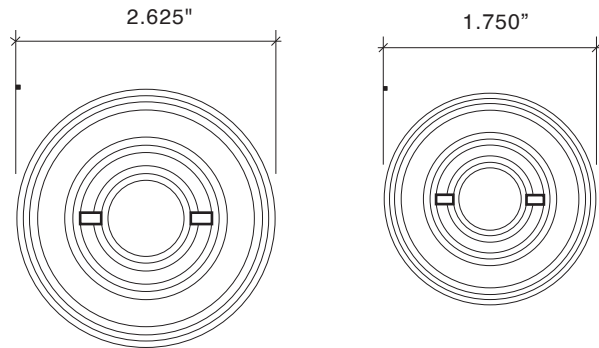

Traditional Deadbolt



- Solid Forged Brass
- Traditional Design Trim with Oval Turnpiece

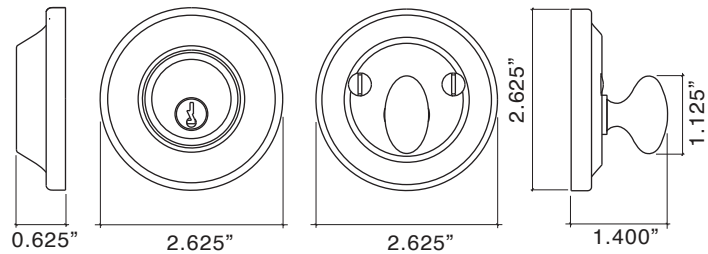

Colonial Deadbolt



- Solid Forged Brass
- Colonial Design Trim with Bit Key Turnpiece

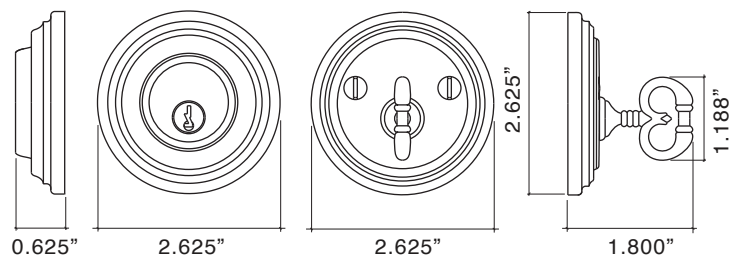

All Prices in US Dollars - Prices Subject to Change Without Notice
Please Check with Von Morris Customer Service for Up to Date Pricing.



Traditional Handrail Bracket

		Standard	Distressed	ETERNA
26-5017	Small Traditional Handrail Brackets	128.80	151.20	168.00
26-5026	Large Traditional Handrail Brackets	134.40	156.80	179.20



Colonial Handrail Bracket

		Standard	Distressed	ETERNA
26-5117	Small Colonial Handrail Bracket	128.80	151.20	168.00
26-5126	Large Colonial Handrail Bracket	134.40	156.80	179.20



Handrail Bracket

		Standard	Distressed	ETERNA
2600	Handrail Bracket without Rose	99.18	116.42	129.36
2600/1	Handrail Bracket Radius Saddle Adaptor	21.25	24.95	27.72



Radius Saddle Adapter 2600/1

• 1.0" wide x 2.0" long - 0.6875" radius.

Available at additional cost.

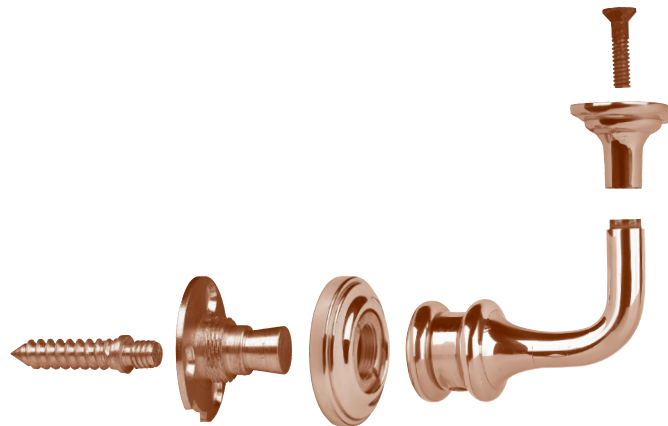



Traditional Handrail Bracket Set

Von Morris Handrail Brackets use an innovative design allowing you to use the base bracket and elbow with any Von Morris Rose. The base attaches to the wall with a 5/16" x 2.0" hanger bolt and three #10 x 2.0" steel wood screws. The Rose is then attached to the base plate with a retainer nut. The base allows for 45° of rotation so that Roses can be properly aligned, yet prevents full rotation. The elbow fits over the large diameter boss on the base and is secured with a set screw. The saddle is attached to bottom of the rail with two #12 x 1.25" wood screws. Handrail Brackets are supplied standard for flat bottom rail. A Radius Saddle Adapter is available for an additional charge. Screws for the Radius Saddle Adapter are offset equally from the centerline to provide additional stability and to prevent the rail from rocking. Any Von Morris Rose can be used with this Handrail Bracket.

Dimensions:

Projection: Wall to centerline of railing: 2.625".

Clearance: 1.625" using 2.0" outside diameter rail.

Standard Saddle: 1.0" wide x 2.0" long - flat.

Fasteners:

5/16" x 2.0" hanger bolt and three #12 x 2.0" steel screws.



Colonial Handrail Bracket Set

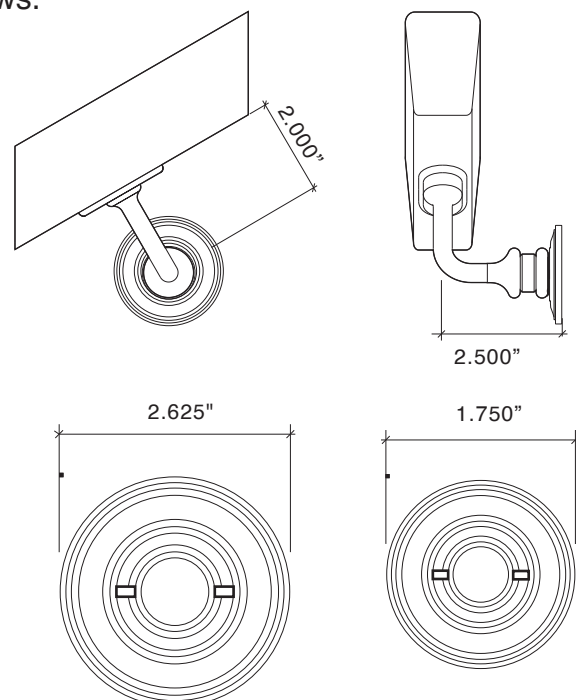

All Prices in US Dollars - Prices Subject to Change Without Notice
Please Check with Von Morris Customer Service for Up to Date Pricing.



Traditional Turnpiece Trim

Description	Standard	Distressed	ETERNA
9538/01 Mortise Bolt w/ Traditional Rose w/Turnpiece	123.20	151.20	184.80
9538/02 Mortise Bolt w/ Traditional Rose w/Turnpiece and ER Rose	150.08	185.92	229.60
8860-001 1.25" Traditional Rose with Turnpiece	58.24	76.16	95.20
8860-002 1.25" Traditional Rose cut for ER Button	26.88	34.72	47.80
8860-003 1.25" Traditional Rose cut for Bit Key	26.88	34.72	47.80
8863-001 Bit Key Head Turnpiece on Rose	63.84	84.00	106.40
8880 Oval Turnpiece	31.36	41.44	50.40
8882 Bit Key Head Turnpiece	36.96	49.28	61.60
8890 Traditional Cylinder Collar	28.00	36.96	45.92

All IML Privacy and Tubular Mortise Bolt Privacy Sets come with ER Trim Standard on the Exterior. Exterior Bit Key Trim can be substituted for no additional charge.

Traditional Turnpiece Trim

Traditional Escutcheon with Traditional Turnpiece



8860-001

- Solid Forged Brass Turnpiece.
- Machined Brass Escutcheon.
- 5mm x 5mm Spindle positioned on the diamond.
- Furnished with #4 Solid Brass oval head slotted wood screws finished to match Escutcheon and Turnpiece.
- Stocked in Standard Finishes

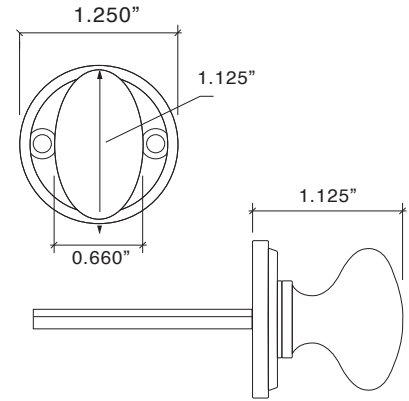

Traditional Emergency Release Trim



8860-002

- Machined Brass Escutcheon
- Wrought Brass Hole Cover is included and finished to match Escutcheon.
- Furnished with #4 Solid Brass oval head slotted wood screws finished to match Escutcheon.
- Stocked in Standard Finishes

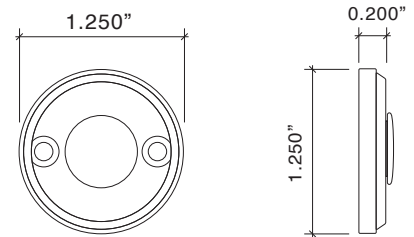

Traditional Bit Key Trim



8860-003

- Machined Brass Escutcheon.
- Furnished with #4 Solid Brass oval head slotted wood screws finished to match Escutcheon.
- Stocked in Standard Finishes

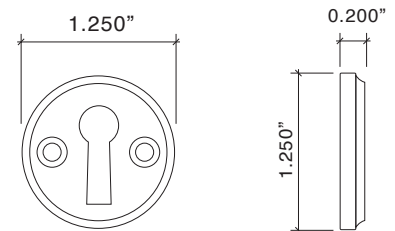

Traditional Cylinder Collar



8890

- Solid Forged Brass.
- Stocked in Standard Finishes

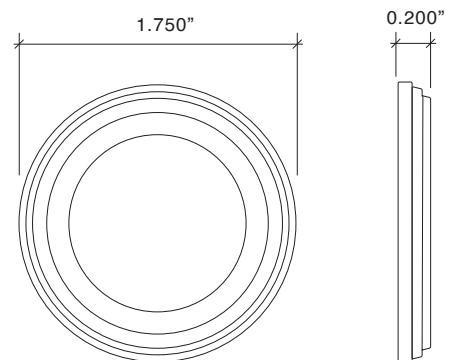

All Prices in US Dollars - Prices Subject to Change Without Notice
Please Check with Customer Service for Up to Date Pricing.



Colonial Turnpiece Trim

	Description	Standard	Distressed	ETERNA
9538/11	Mortise Bolt w/ Colonial Rose w/Turnpiece	123.20	151.20	184.80
9538/12	Mortise Bolt w/ Colonial Rose w/Turnpiece and ER Rose	150.08	185.92	229.60
8861-001	1.25" Colonial Rose with Turnpiece	58.24	76.16	95.20
8861-002	1.25" Colonial Rose cut for ER Button	26.88	34.72	47.80
8861-003	1.25" Colonial Rose cut for Bit Key	26.88	34.72	47.80
8863-001	Bit Key Head Turnpiece on Rose	63.84	84.00	106.40
8880	Oval Turnpiece	31.36	41.44	50.40
8882	Bit Key Head Turnpiece	36.96	49.28	61.60
8890	Traditional Cylinder Collar	28.00	36.96	45.92

All IML Privacy and Tubular Mortise Bolt Privacy Sets come with ER Trim Standard on the Exterior. Exterior Bit Key Trim can be substituted for no additional charge.

Colonial Turnpiece Trim

Colonial Escutcheon with Colonial Turnpiece



8861-001

- Solid Forged Brass Turnpiece.
- Machined Brass Escutcheon.
- 5mm x 5mm Spindle positioned on the diamond.
- Furnished with #4 Solid Brass oval head slotted wood screws finished to match Escutcheon and Turnpiece.
- Stocked in Standard Finishes

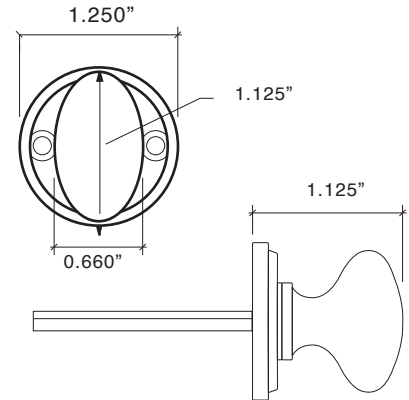

Colonial Emergency Release Trim



8861-002

- Machined Brass Escutcheon
- Wrought Brass Hole Cover is included and finished to match Escutcheon.
- Furnished with #4 Solid Brass oval head slotted wood screws finished to match Escutcheon.
- Stocked in Standard Finishes

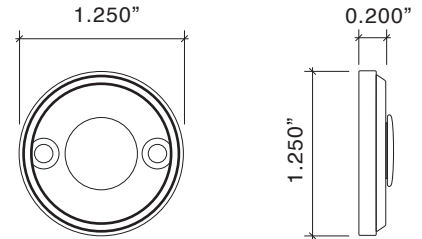

Colonial Bit Key Trim



8861-003

- Machined Brass Escutcheon.
- Furnished with #4 Solid Brass oval head slotted wood screws finished to match Escutcheon.
- Stocked in Standard Finishes

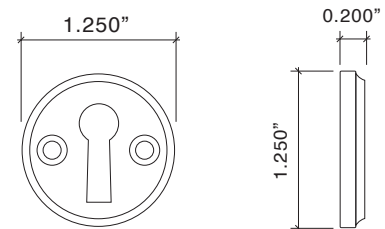

Colonial Bit Key Head Turnpiece



8863-001

- Solid Forged Brass Turnpiece.
- Machined Brass Escutcheon.
- Stainless Steel Spindle positioned on the diamond.
- Furnished with #4 Solid Brass oval head slotted wood screws finished to match Escutcheon and Turnpiece.
- Stocked in all standard finishes.
- 5mm x 5mm Spindle positioned on the diamond.

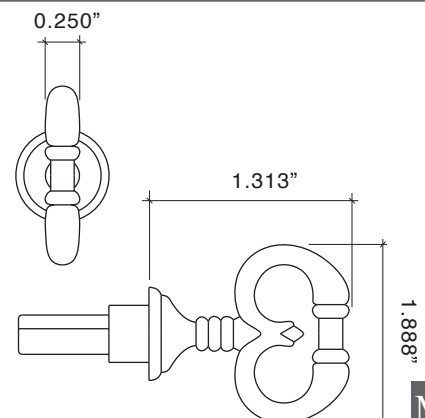

NON-SUITED ACCESSORIES

